

Features

- Nickel silver spring hinge with closed bottom
- Easy click-in mechanism in stainless steel
- Best application mainly in **metal temples**
- One barrel construction
- 75% of recycled nickel silver chips are used in the production of new cases

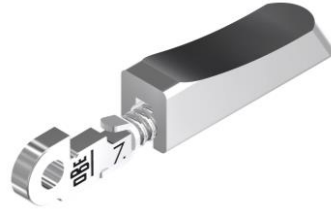

60-08088

soldering

mechanism not exchangeable

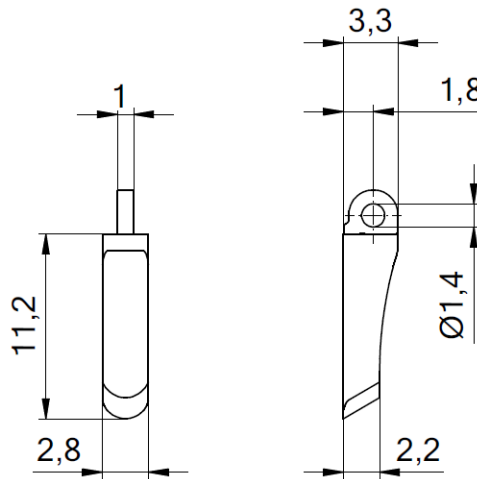

Barreling cap for case 91-20221

Case

Spring mechanism

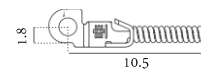
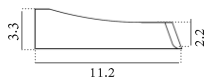

17-08088

60-45002.130

Matching parts

Front hinges
for soldering

Front hinges
for plastic frames 90°

Front hinges
for plastic frames 180°

Step hinges
for soldering

Screws

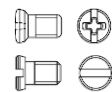
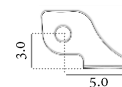
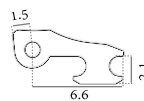
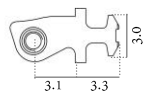
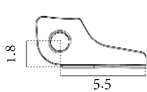

52-05194

33-05106

33-05063

52-05153

99-01813
99-02501