

Features

- Nickel silver spring hinge with closed bottom
- Easy click-in mechanism in stainless steel
- Best application mainly in **metal temples**
- One barrel construction
- 75% of recycled nickel silver chips are used in the production of new cases

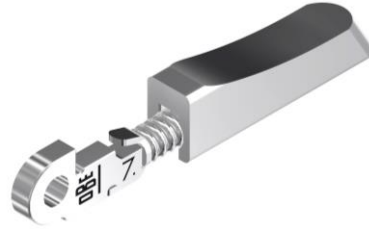

60-08084

soldering

mechanism not exchangeable

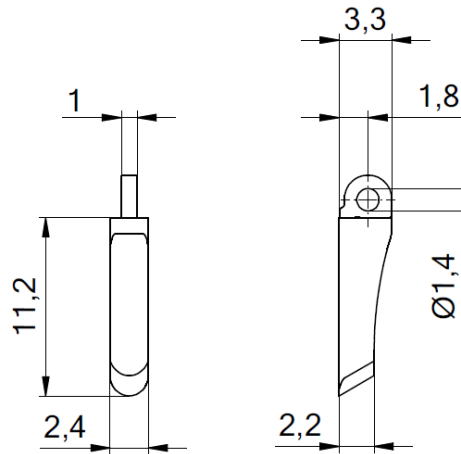

Barreling cap for case 91-20201

Case

Spring mechanism

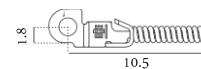
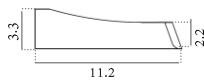

17-08084

60-45002.130

Matching parts

Front hinges
for soldering

Front hinges
for plastic frames 90°

Front hinges
for plastic frames 180°

Step hinges
for soldering

Screws

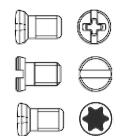
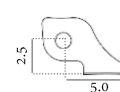
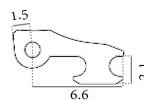
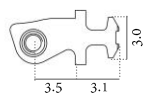
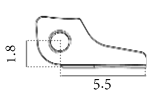

52-05097

33-05104

33-05012

52-05111

99-01811

99-02525

99-04811