

Features

- Nickel silver spring hinge with closed bottom
- Easy click-in mechanism in stainless steel
- Best application mainly in **metal temples**
- One barrel construction
- 75% of recycled nickel silver chips are used in the production of new cases



60-08080

soldering

mechanism not exchangeable

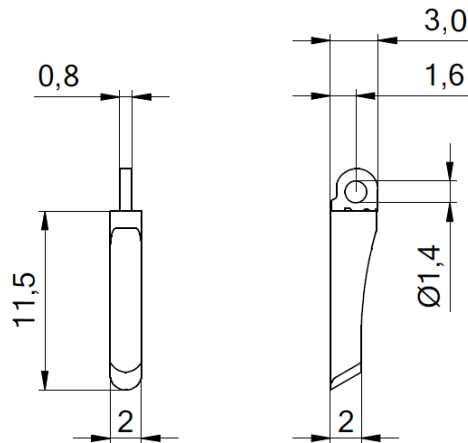

Barreling cap for case 91-20222

Case

Spring mechanism

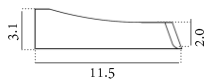

17-08080

60-45001.220

Matching parts

Front hinges
for soldering

Front hinges
for plastic frames 90°

Front hinges
for plastic frames 180°

Step hinges
for soldering

Screws

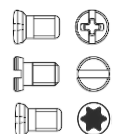
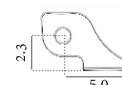
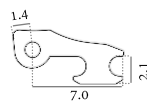
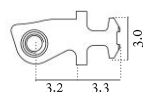
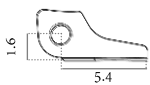

52-05075

33-05105

33-05010

52-05112

99-01803

99-02530

99-04803