

Features

- Elegant & short nickel silver spring hinge
- Best application mainly in **metal temples**
- Easy & stable U-shaped click-in mechanism in stainless steel
- Zero rocking & easy adjustment with flexUno two barrel construction
- 75% of recycled nickel silver chips are used in the production of new cases



patented

60-04064.XXX

soldering

mechanism exchangeable

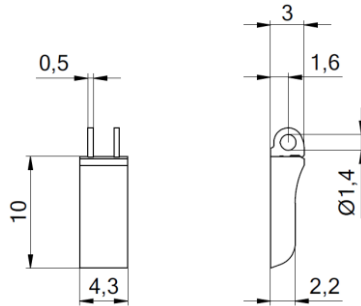

Barreling cap for case 91-20212

Case

Side hinge

Spring mechanism

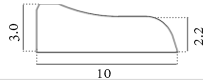

17-04064

44-44064

60-04064.050

Matching parts

Front hinges
for soldering

Front hinges
for welding

Front hinges
for plastic frames 90°

Front hinges
for plastic frames 180°

Step hinges
for soldering

Screws

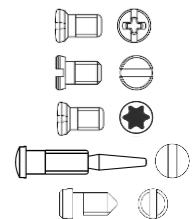
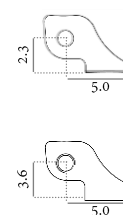
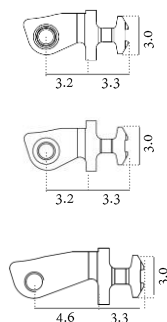
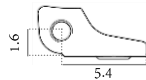
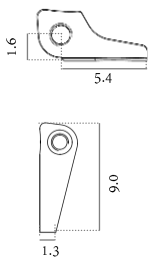

52-05064
52-04264

52-04064

33-05164
33-04164 off center
33-02364
0°/6° inclination

33-04064

52-05164
52-05264

99-01816
99-02503
99-04816
99-02503.800
self aligning for break off
99-02591 self aligning