

Features

- Elegant & short 100% stainless steel spring hinge
- Best application mainly in **metal temples**
- Easy & stable U-shaped click-in mechanism
- Zero rocking & easy adjustment with flexUno two barrel construction
- Zero corrosion



patented

60-44062

soldering or laser welding

mechanism exchangeable

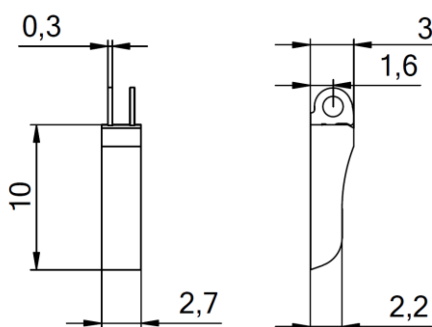

Barreling cap for case 91-20219

Case

Side hinge

Spring mechanism

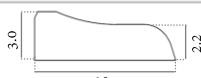

17-44062

44-44062

60-04063.030

Stainless steel matching parts

Front hinges  
for soldering

Front hinges  
for plastic frames 90°

Screws

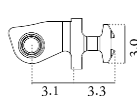
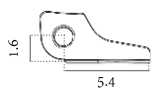

52-45062

33-44162

99-01730  
99-02016  
99-04724