

Features

- Nickel silver spring hinge in low profile
- Flat design enables elegant integration in **titanium or aluminium temples**
- 75% of recycled nickel silver chips are used in the production of new cases



60-04088

fixing in temple groove

loose mechanism parts

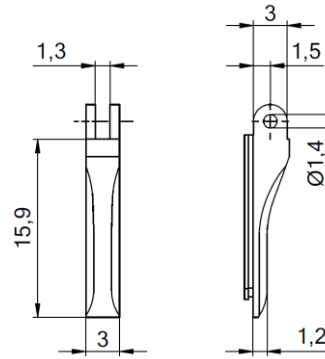

Case

Plunger

Spring bolt

Spring

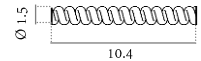
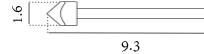
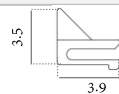
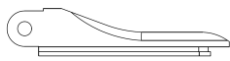

60-04088.023

11-20132

11-20133.041

97-17899

Matching parts

Front hinges
for soldering

Front hinges
for welding

Front hinges
for plastic frames 90°

Rivet hinges /
Rivets

Screws

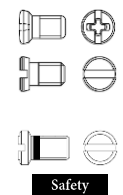
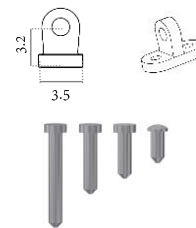
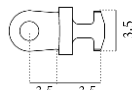
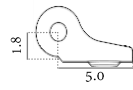
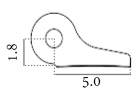

52-05101

52-04266 titanium

33-05067

51-05005

11-20247 - 8.0 mm
11-20251 - 5.4 mm
11-20245 - 4.2 mm
11-20246 - 3.0 mm

99-01813
99-02501
99-01539