

FRAMES MADE FROM SPECIAL MATERIALS → FLEX

C'Flex

SLIDING SPRING HINGES

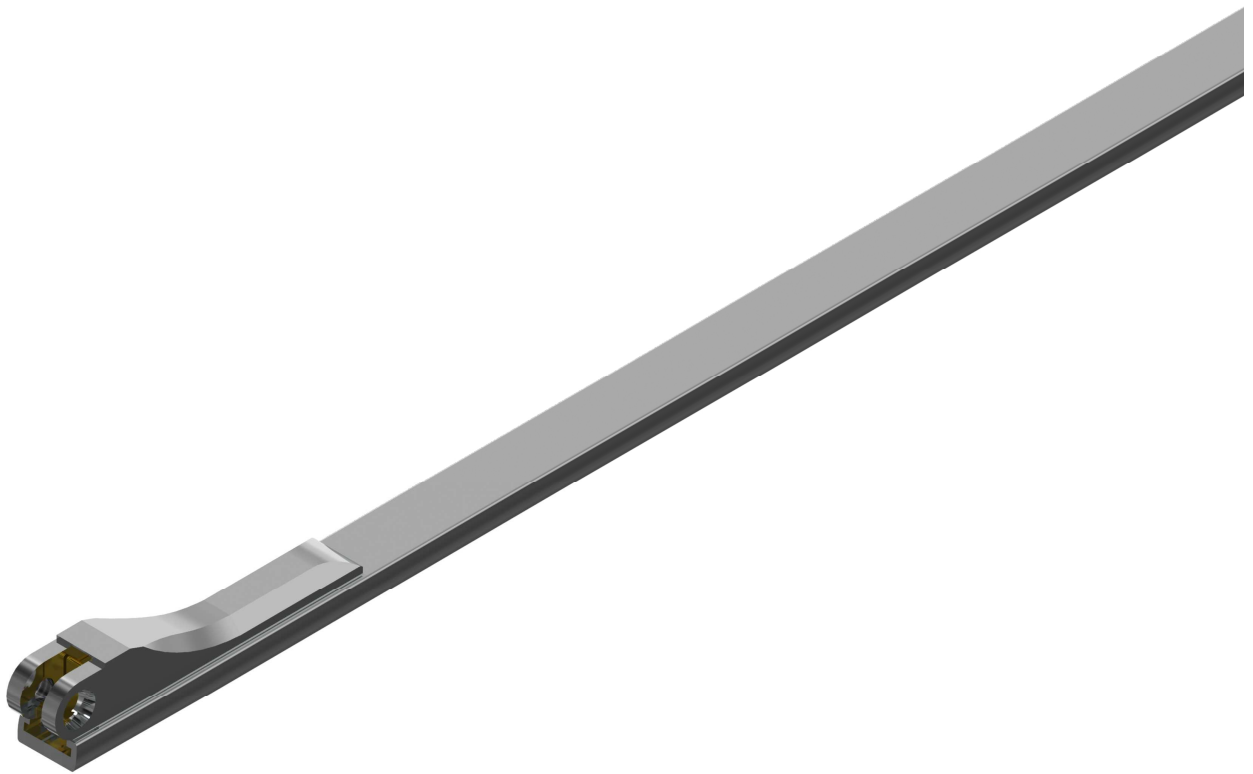

Gliding precision – timeless style

60-04088

- Spring hinge with sliding mechanism
- Flat design
- Case made from nickel silver
- Ideal for titanium and aluminum temples
- 75% of recycled nickel silver chips are used in the production of new cases

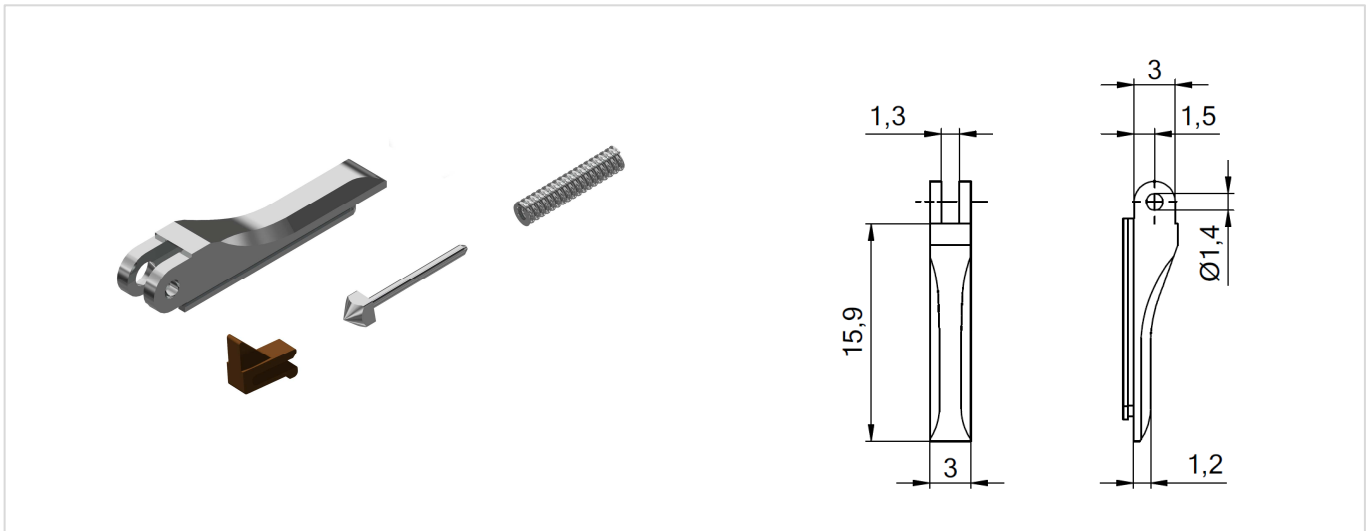

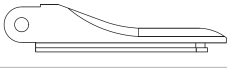
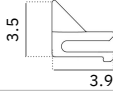
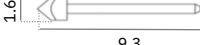
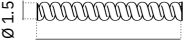
Case	Plunger	Spring bolt	Coil spring
			
60-04088.023	11-20132	11-20133.041	97-17899

Matching parts

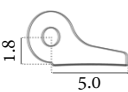
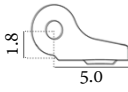
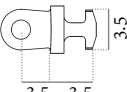
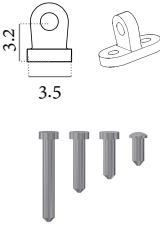
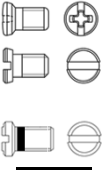
Front hinges for soldering	Front hinges for welding	Front hinges for plastic frames 90°	Rivet hinges / Rivets	Screws
				
52-05101	52-04266 titanium	33-05067	51-05005 11-20247 11-20251 11-20245 11-20246	99-01813 99-02501 99-01539