

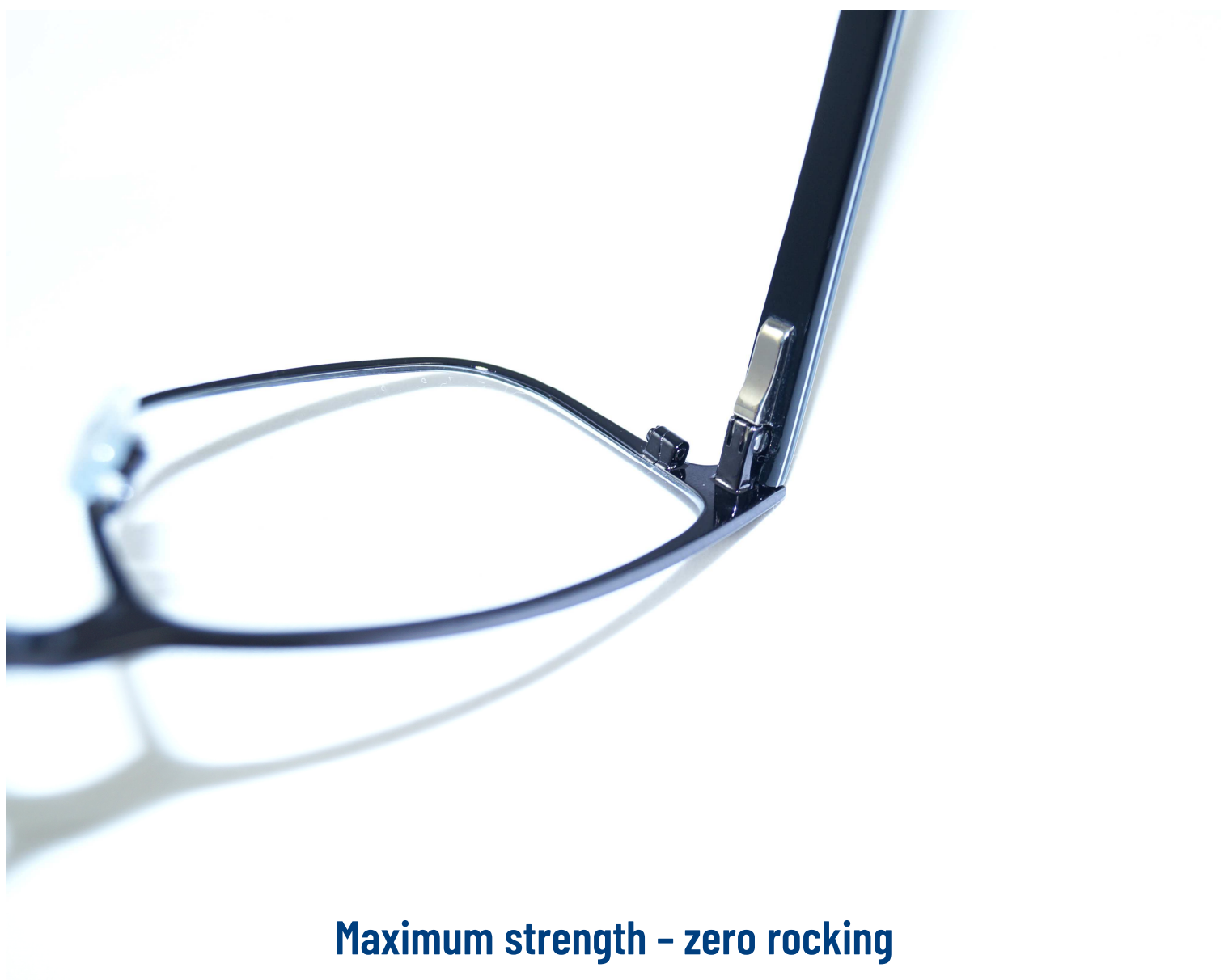











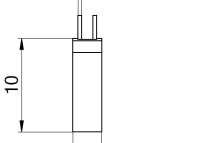
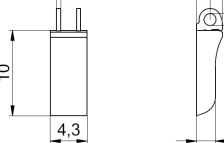

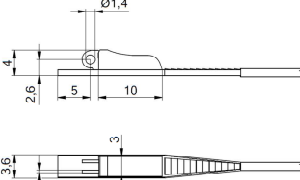
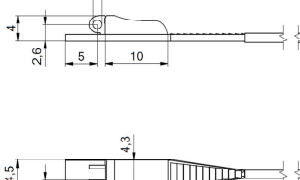



























ACETATE / METAL & COMBINATION FRAMES → CLASSIC TWO BARREL FLEX



Maximum strength – zero rocking



- Spring hinge made from nickel silver
- Stable U-shaped mechanism in stainless steel
- Zero rocking & easy adjustment
- Optionally exchangeable mechanism
- 75% of recycled nickel silver chips are used in the production of new cases

	2.7 mm 60-04062	3.0 mm 60-04063	4.3 mm 60-04064
Solutions for metal frames			
Solutions for acetate frames			
Matching parts for			
Front hinges 180° for soldering	 52-05069	 52-05067	 52-05064
Front hinges 90° for soldering	-	 52-04263	 52-04264
Front hinges 180° for Welding	 52-04062	 52-04063	 52-04064
90° front hinges for plastic frames 0°/ 6° inclination	 33-05062  33-04262 off center - -	 33-05363  33-04163 off center  33-04067  33-02363	 33-05164  33-04164 off center -  33-02364
Front hinges for plastic frames 180°	 33-04062	 33-04063	33-04064
Step hinges for soldering	 - 52-05462 -	 52-05363  52-05463  52-05563	 52-05164  52-05264 -
Screws	 99-01730  99-02016  99-04724 -  99-02016.800 self aligning for break off	 99-01814  99-02524  99-04814 -  99-02524.800 self aligning for break off	 99-01816  99-02503  99-04816 -  99-02591  99-02503.800 self aligning for break off

33-04220.000.0Y



BARCODE

- 90° design front hinge
- Matching to flexUno 3.0 mm
- 5 bar design eyecatcher
- Inserted flush on acetate level or embossed

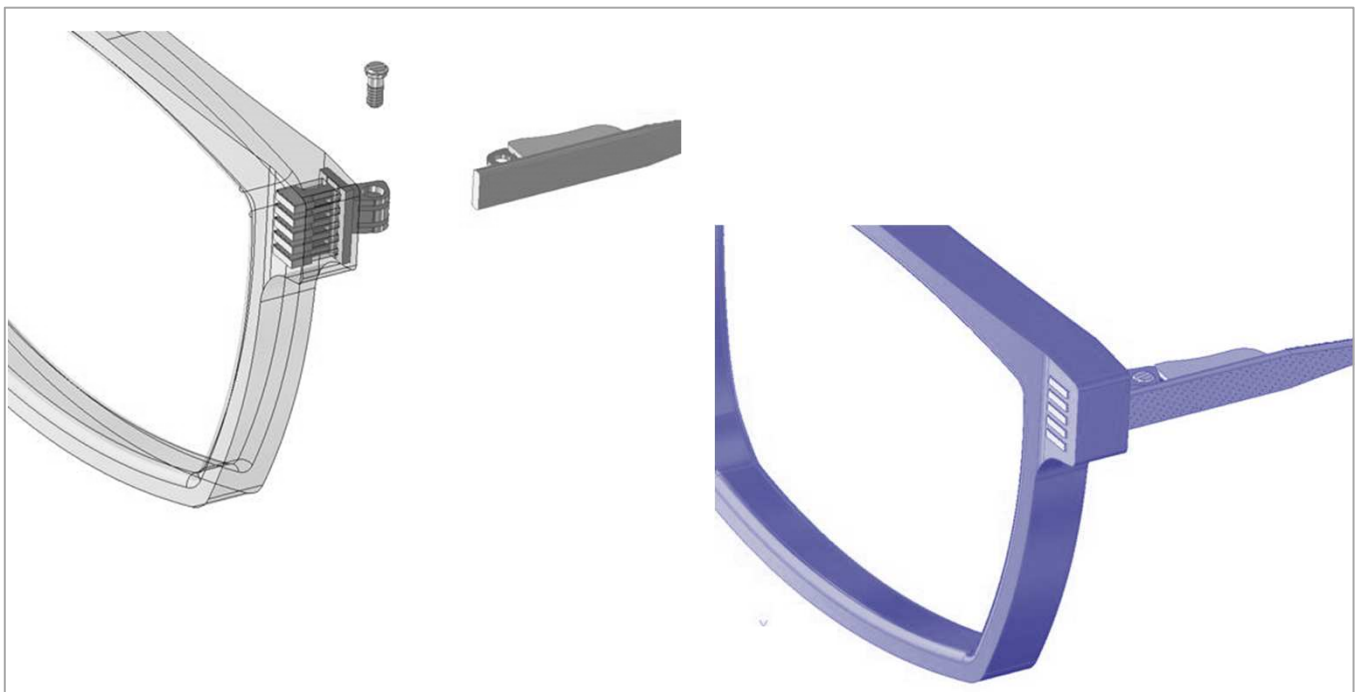
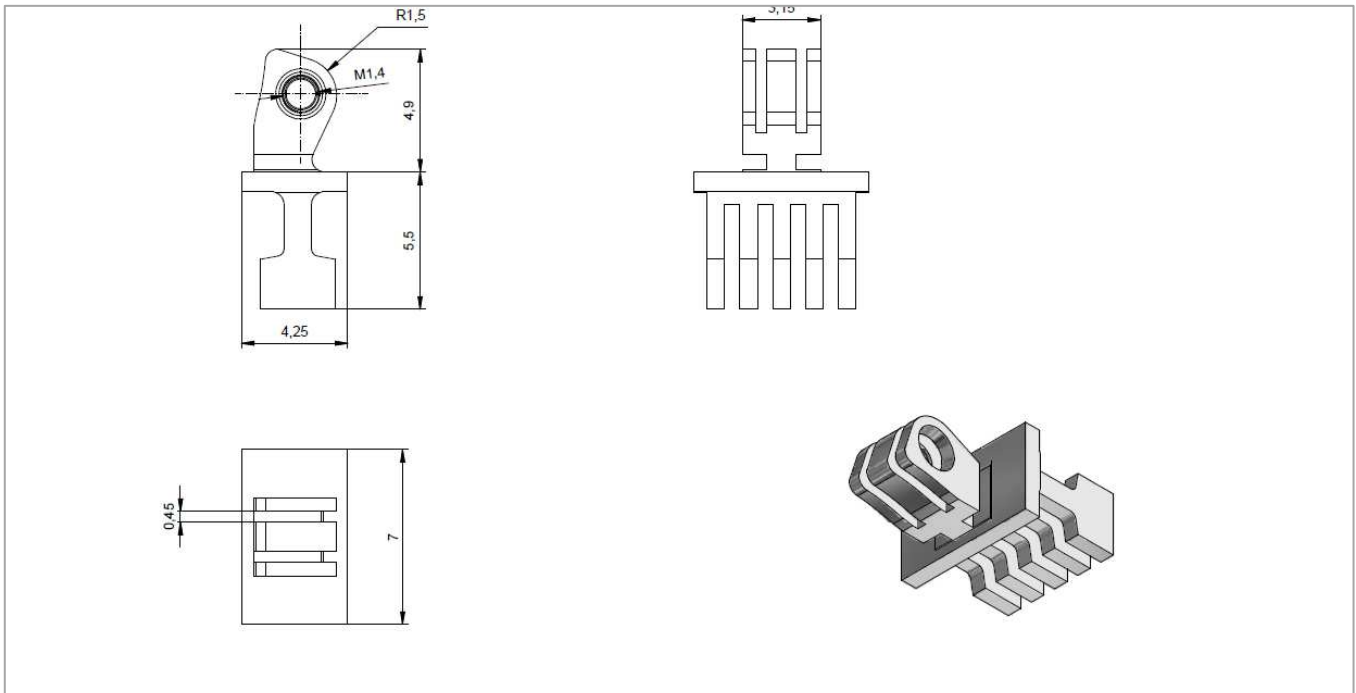



OBE GmbH & Co. KG · Turnstr. 22 · 75228 Ispringen · Germany
Tel. +49 7231 802-0 · www.obe.de · info@obe.de