

Features

- Nickel silver short hinge on wire – nickel plated
- Best application in **injected temples**
- Easy & stable U-shaped click-in mechanism in stainless steel
- Zero rocking & easy adjustment with flexUno two barrel construction
- 75% of recycled nickel silver chips are used in the production of new cases

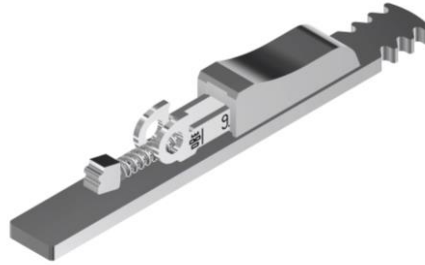

patented

73-04063.900

injection

mechanism exchangeable

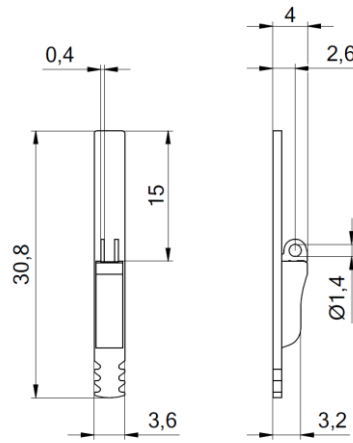

Barreling cap for case 91-20217

Case

Side hinge

Spring mechanism

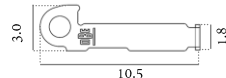
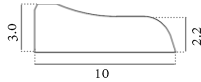

17-04063

44-44063

60-04063.030

Matching parts

Front hinges
for soldering

Front hinges
for welding

Front hinges
for plastic frames 90°

Front hinges
for plastic frames 180°

Step hinges
for soldering

Screws

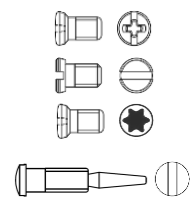
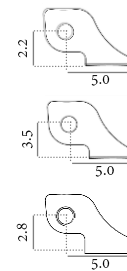
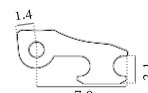
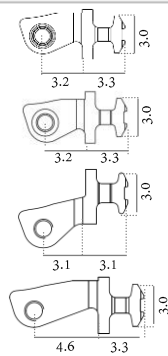
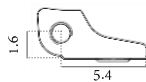
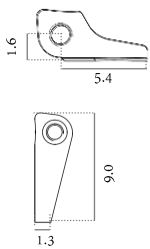

52-05067
52-04263

52-04063

33-05363
33-04163 off center
33-04067
33-02363
0°/6° inclination

33-04063

52-05363
52-05463
52-05563

99-01814
99-02524
99-04814
99-02524.800
self aligning for break off