

Features

- Nickel silver short hinge on wire – nickel plated
- Best application in **injected temples**
- Easy & stable U-shaped click-in mechanism in stainless steel
- Zero rocking & easy adjustment with flexUno two barrel construction
- 75% of recycled nickel silver chips are used in the production of new cases

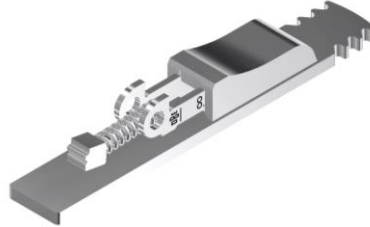

patented

73-04064.900

injection

mechanism exchangeable

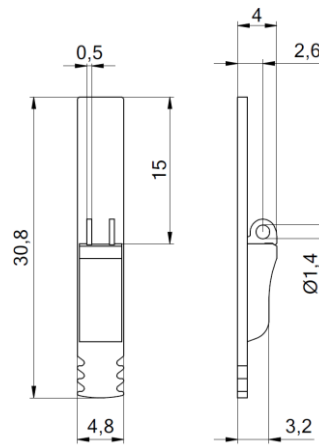

Barreling cap for case 91-20212

Case

Side hinge

Spring mechanism

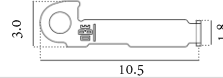
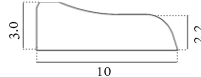

17-04064

44-44064

60-04064.050

Matching parts

Front hinges  
for soldering

Front hinges  
for welding

Front hinges  
for plastic frames 90°

Front hinges  
for plastic frames 180°

Step hinges  
for soldering

Screws

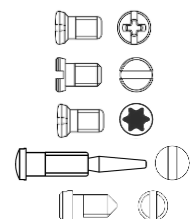
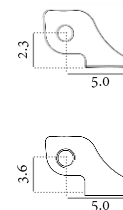
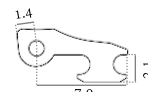
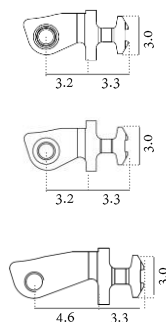
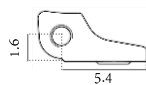
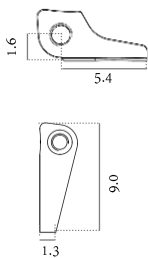

52-05064  
52-04264

52-04064

33-05164  
33-04164 off center  
33-02364  
0°/6° inclination

33-04064

52-05164  
52-05264

99-01816  
99-02503  
99-04816  
99-02503.800  
self aligning for break off  
99-02591 self aligning